



Movirack Mobile Pallet Racking

High-density storage on mobile racking units





Movirack system: general features

The Movirack solution compacts the racking, considerably increasing storage capacity while maintaining direct access to each product.

The racking units are installed over guided mobile bases that slide laterally, thus eliminating the need for aisles (which only open when accessed).

The operator gives the order to automatically open the unit, either by remote control or manually by flicking a switch.

The mobile bases have motors, travel elements, electronics and several safety systems to ensure safe, efficient operation.

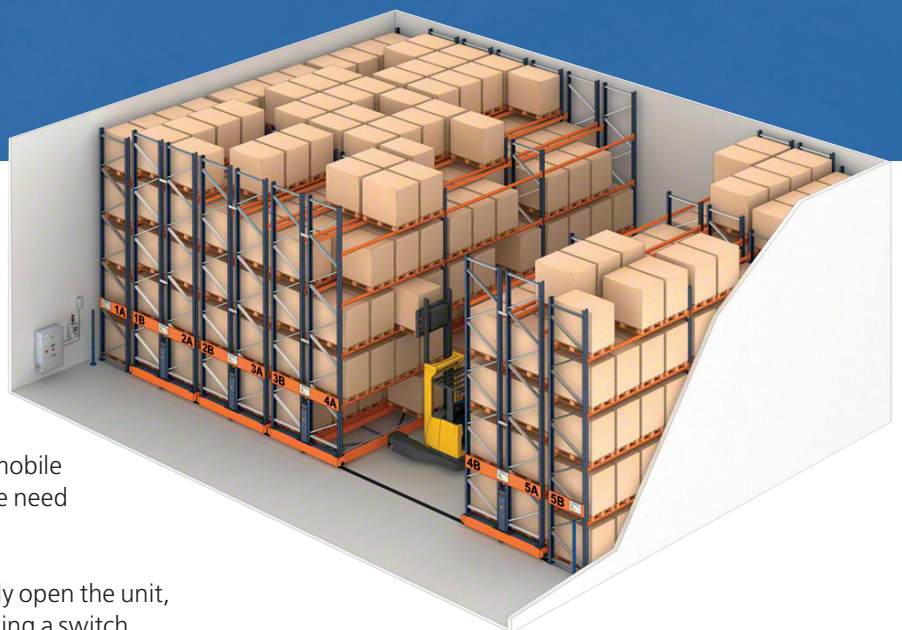



Warehouse using conventional pallet storage.



Warehouse using mobile bases. The same capacity with a single aisle occupies less space.



Warehouse using mobile bases. Utilising the most space possible considerably increases storage capacity.

Key advantages

Direct access to any pallet in storage

As these racking units are installed over bases, merely opening up the corresponding aisle provides direct access to the desired pallet.

Maximisation of your available space

This excellent use of available space is thanks to two basic premises: increasing the storage capacity and reducing the storage area to be built.

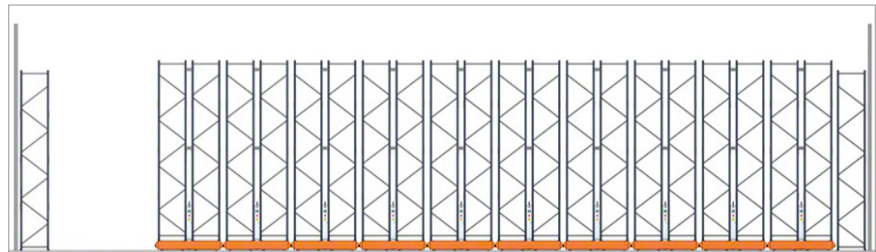

Example of a pallet racking system using mobile bases.

This figure illustrates the sizeable increase in capacity that a mobile base system provides (80% to 120% more than a pallet rack system). The increase depends on the type of forklift being used, the facility size and the number of open aisles.

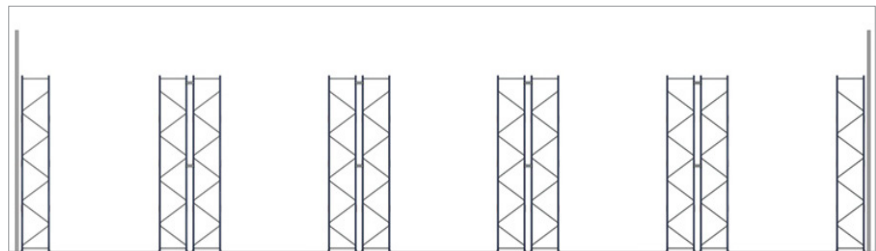

Example of a conventional pallet racking system.



Applications

These are some examples of the Movirack system's multiple applications:

Palletised product storage

- General storage,
- products with average or low-level turnover,
- refrigerated storerooms,
- interim or shipping warehouses.

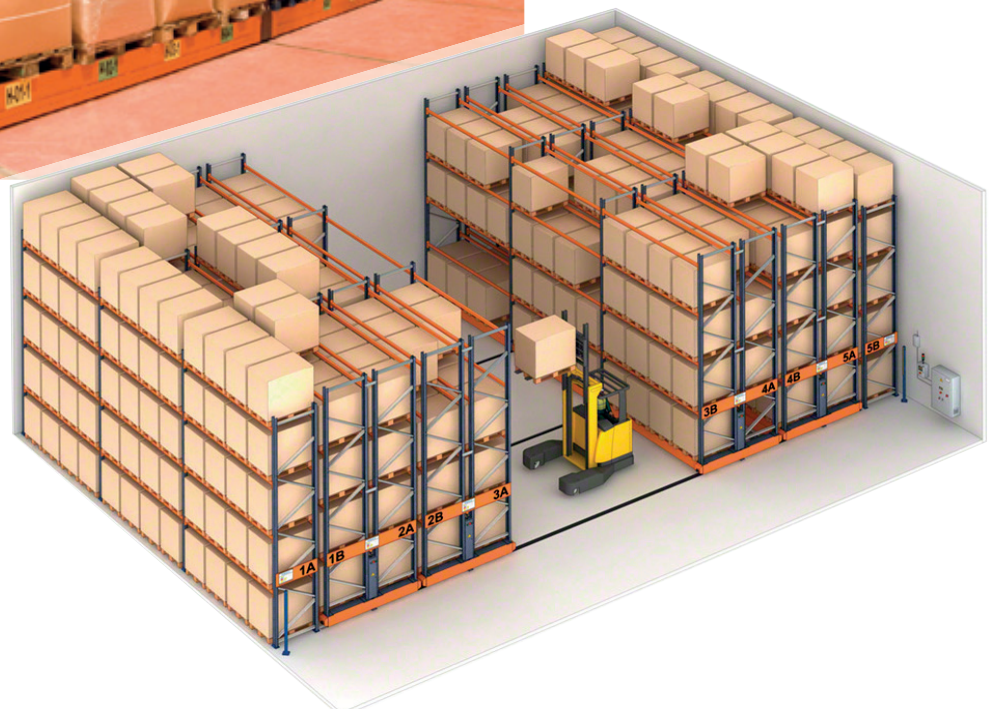



Warehouse with cantilever racks

- For sheets, reels, and large or irregular-sized products.

In these cases, the same utilisation criteria for palletised products is applied.

Both conventional forklifts (counterbalanced and reach trucks) and those used for lengthy products (side-loading and four-way forklifts) can be used.

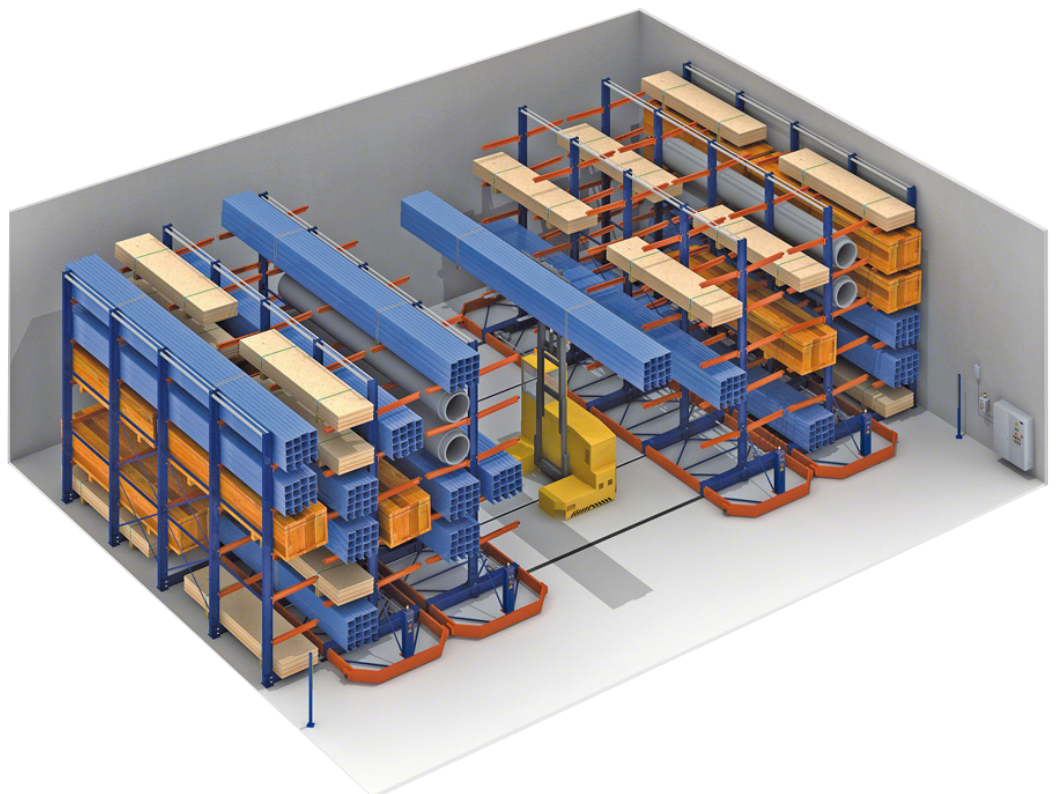

Refrigerated warehouses

The Movirack system is ideal for low or medium-height refrigerated or freezer warehouses because:

- As a high-density system, it has a **quick return** on investment.
- **Every pallet can be directly accessed.** This is very useful when there are few pallets per item.
- **Energy savings are increased** in terms of generating cold air. The air is spread over a larger number of pallets in storage, thus reducing the expense per pallet.
- **There is better air circulation** in down times when using the parking option, which increases the separation between racks to spread the aisle space more equidistantly.
- With the **parking option**, if enough space is available, aisles can be used to pick individual items from the lower racks.
- The **use of a conventional forklift** allows for direct access from the dock area to different points on the racking unit.

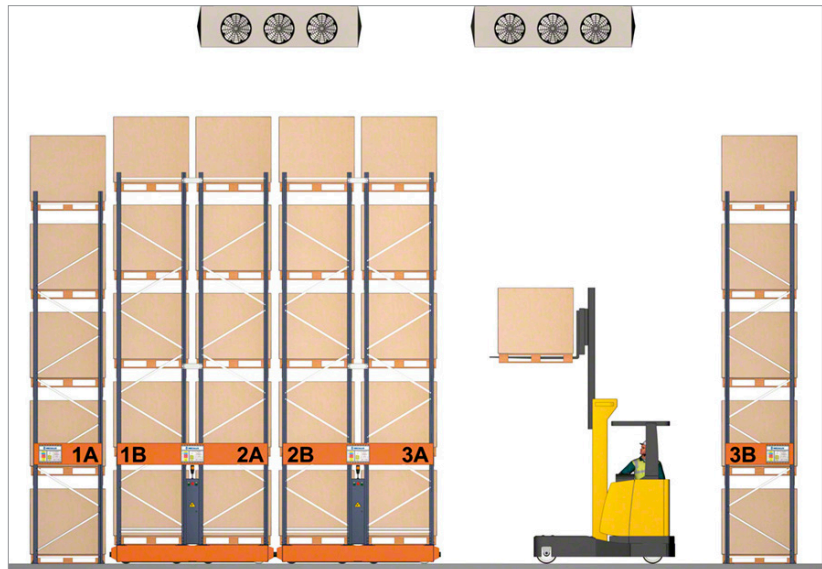

Option with a single open aisle.

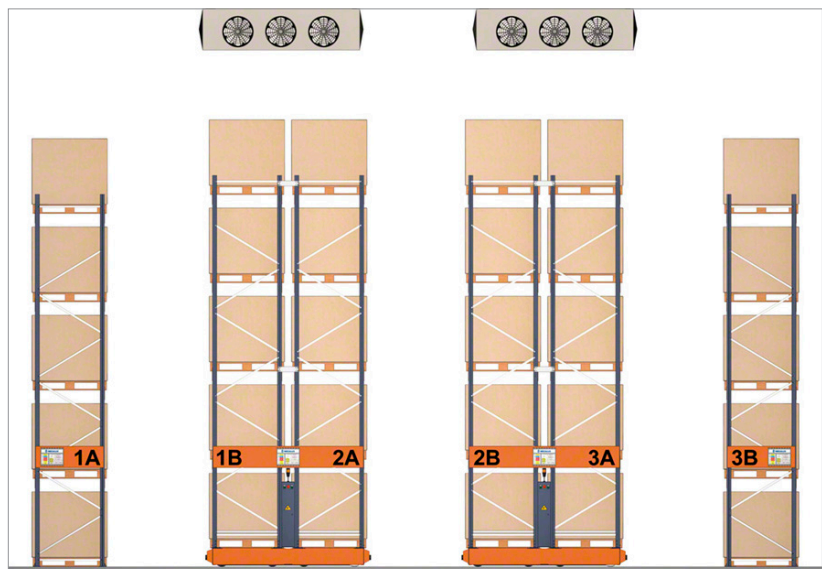

Parking option.



Basic components

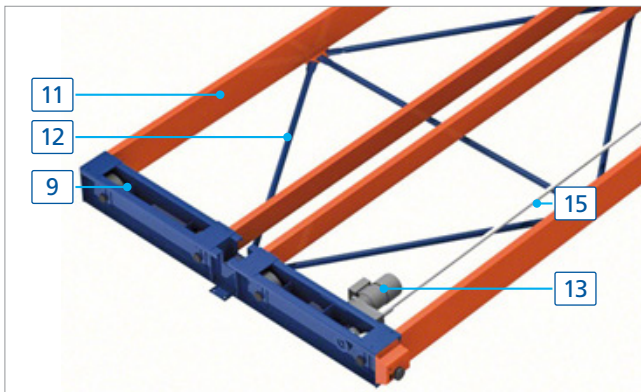
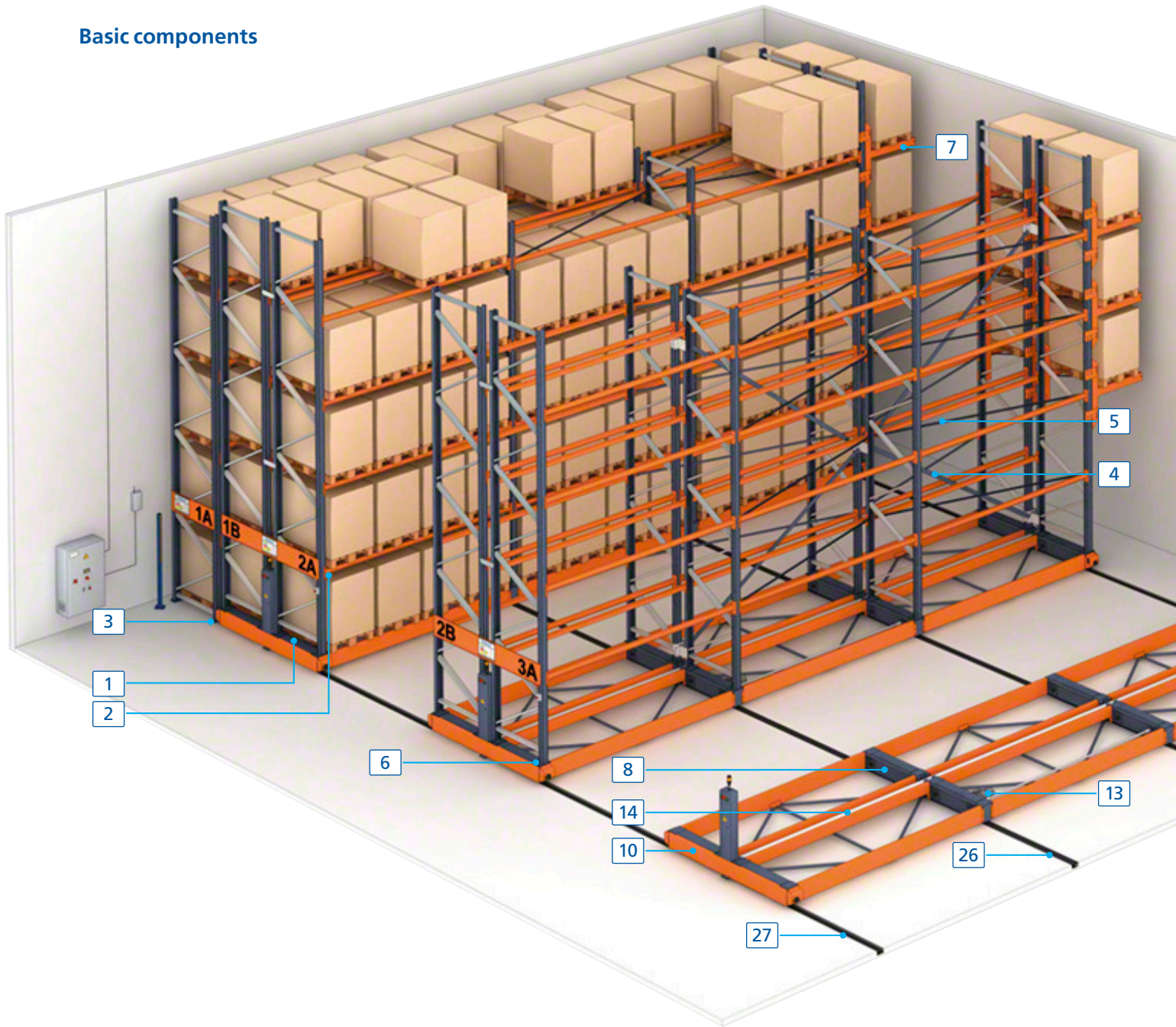

Racks

1. Frame
2. Beam
3. Anchorage
4. Vertical cross bracing
5. Horizontal cross bracing
6. Base fasteners
7. Pick and deposit (P&D) stations (optional)

Mobile bases

8. Roller carriage/drive carriage
9. Guide carriage
10. End of carriage
11. Base beam
12. Bracing set
13. Motor
14. Cable channel
15. Drive shaft

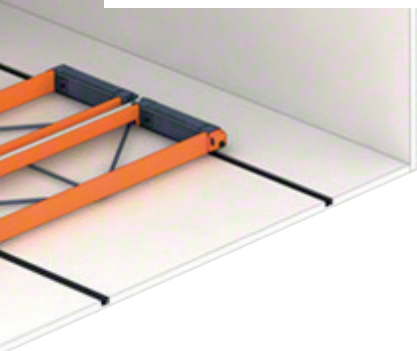
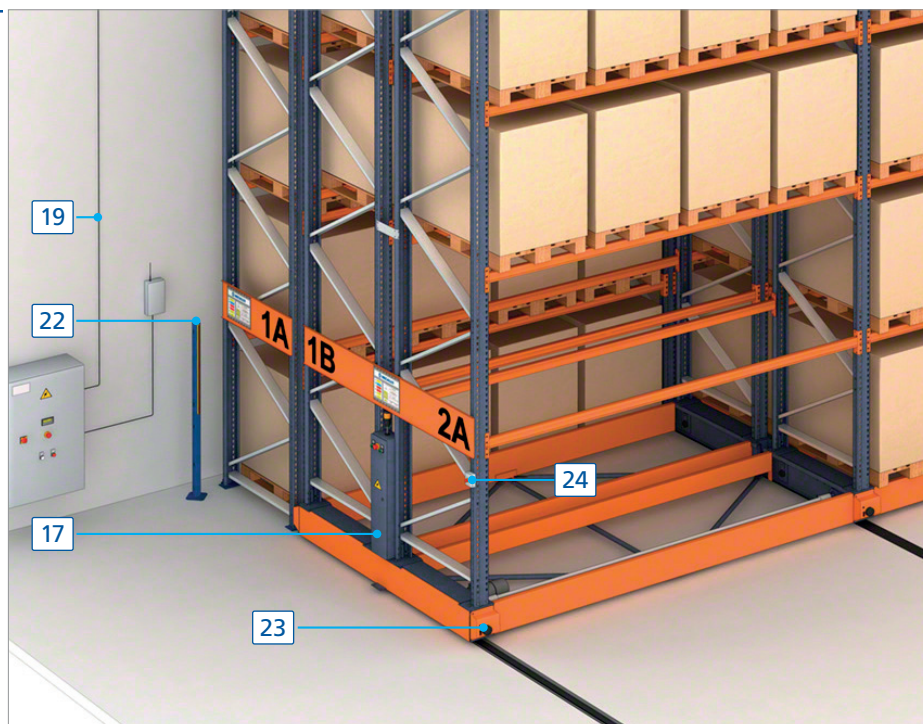

Control and safety elements

16. Main power panel
17. Onboard power panel
18. Control panel
19. Signal and power cables
20. Remote control
21. Control button pad
22. External safety barrier
23. Internal safety barrier and proximity photocell
24. Reset button
25. Emergency stop button

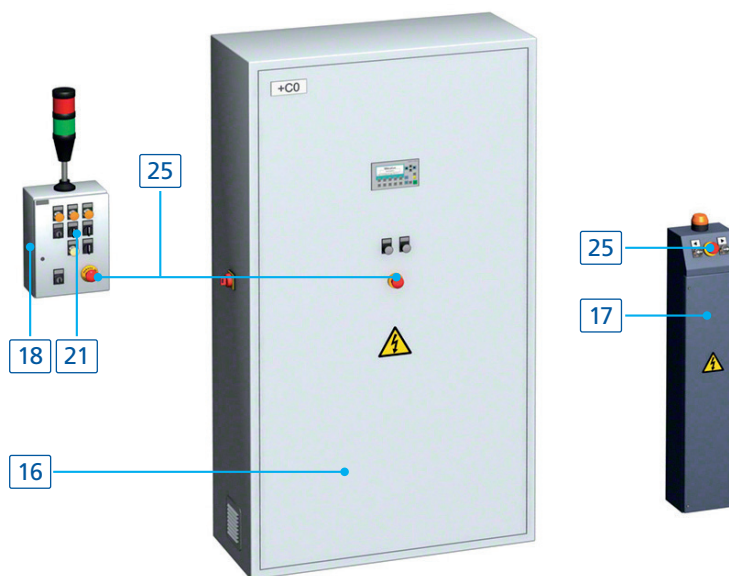

Building systems

Embedded rails

The mobile racking units travel over rails that have first been levelled and anchored and then embedded in the floor.

The solution features smooth rails and guide rails that match the wheels on the carriage. The number of rails depends on the characteristics of each storage system.

They can be installed in many different ways:

- Over a concrete slab foundation.
- Over an existing floor with backfilling.
- Over an existing floor with channels and support joists.
- Over an existing floor with channels.

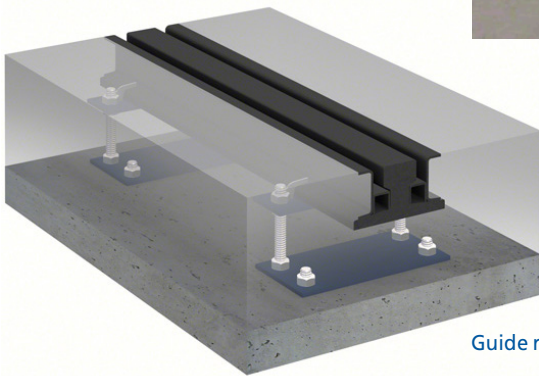

Guide rail

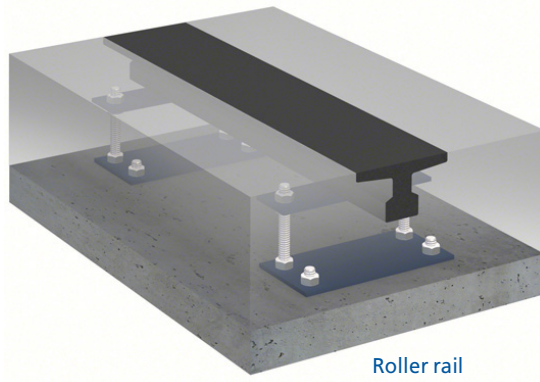

Roller rail

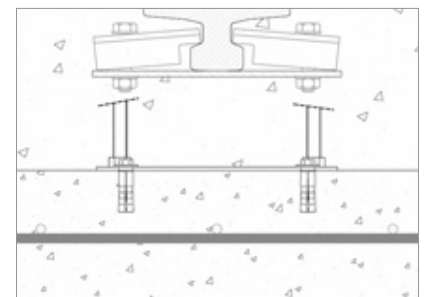

Over a concrete slab foundation.

This system is most often used over a newly built floor.

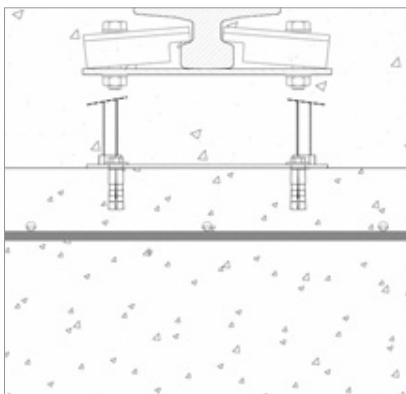

Over an existing floor with backfilling. Appropriate when the floor has adequate resistance but new flooring is to be laid.

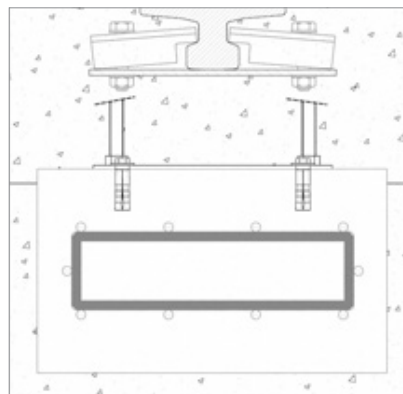

Over an existing floor with channels and support joists. Appropriate when the floor resistance is insufficient or undetermined.

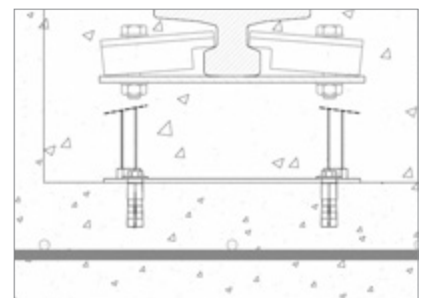

Over an existing floor with channels. Valid when the floor can handle the units without compromising its resistance.



Racks

The storage systems tend to be formed by fixed racking units with access on either one or both sides, and by mobile racking units that always have access on both sides.

Both types have structural systems that are the same as pallet rack units.

However, when calculating the mobile racking system, it is important to take into account the dynamic forces produced by the starting and stopping movements.

There can be levels set for two, three or four pallets, depending on the size and type of load to be stored.

This figure represents the depth of the racks as viewed from the side.

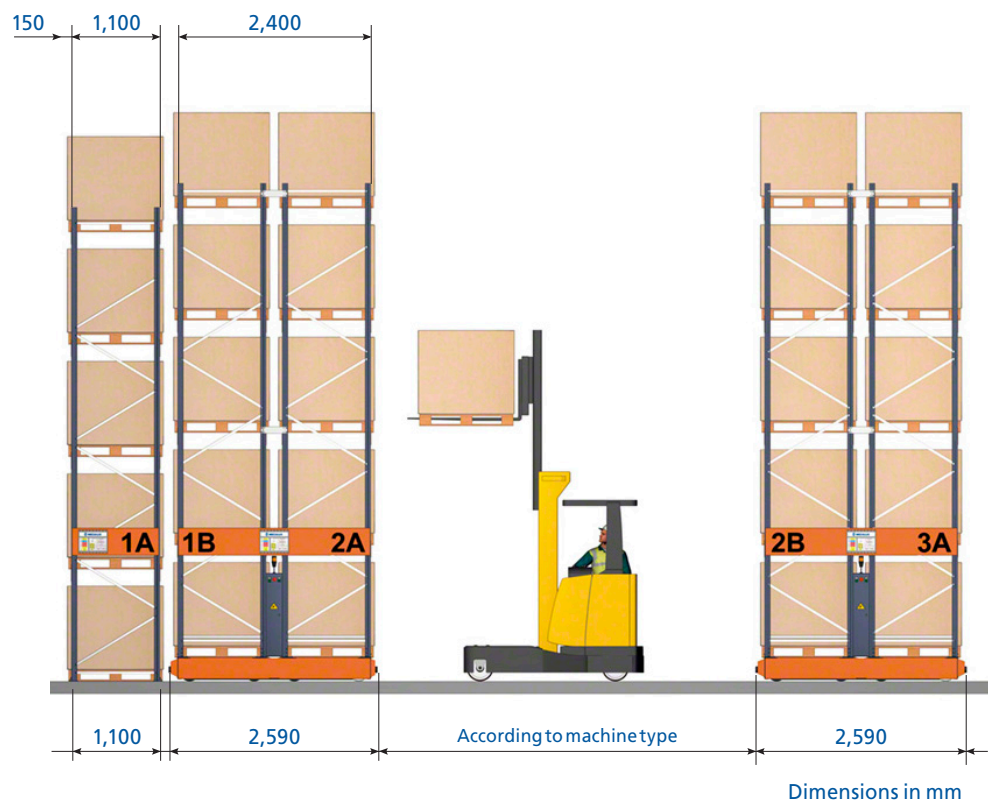

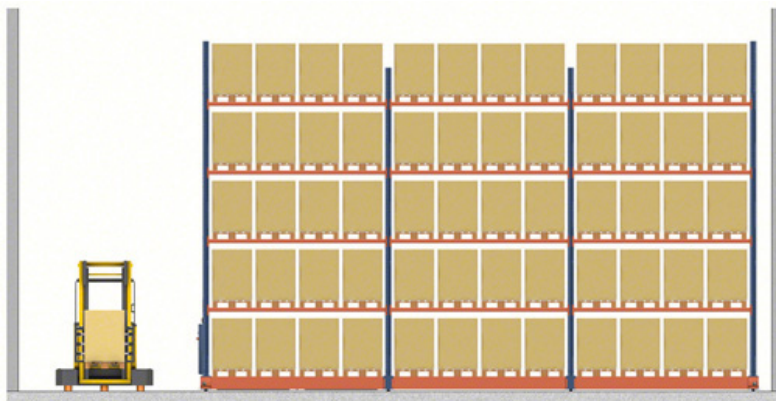

Single-access aisle

With this storage system, the most common option is to have a single main aisle with the racking installed perpendicular to it.

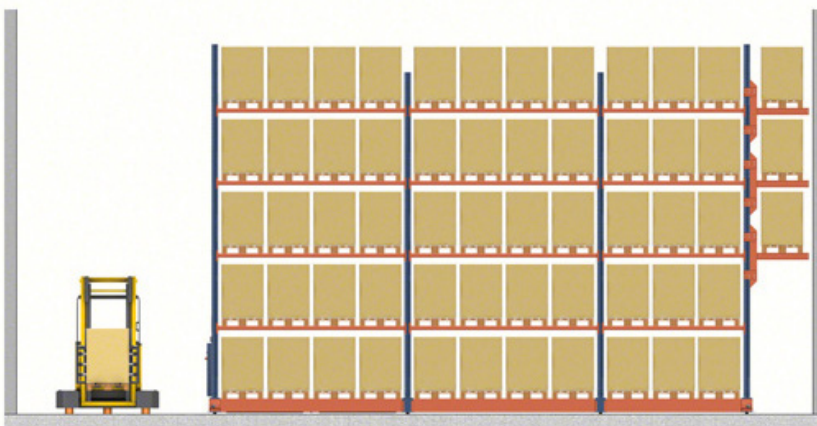

Access aisle plus pedestrian walkway

When necessary, or for safety reasons, the unit closest to the wall can be cantilevered to leave the space below free for a pedestrian walkway or a fire escape route.

Basic components for cantilevered racking units

The structural system, guides and embedding systems, in addition to operational criteria and tolerance factors, are similar to those of facilities with pallet racking.

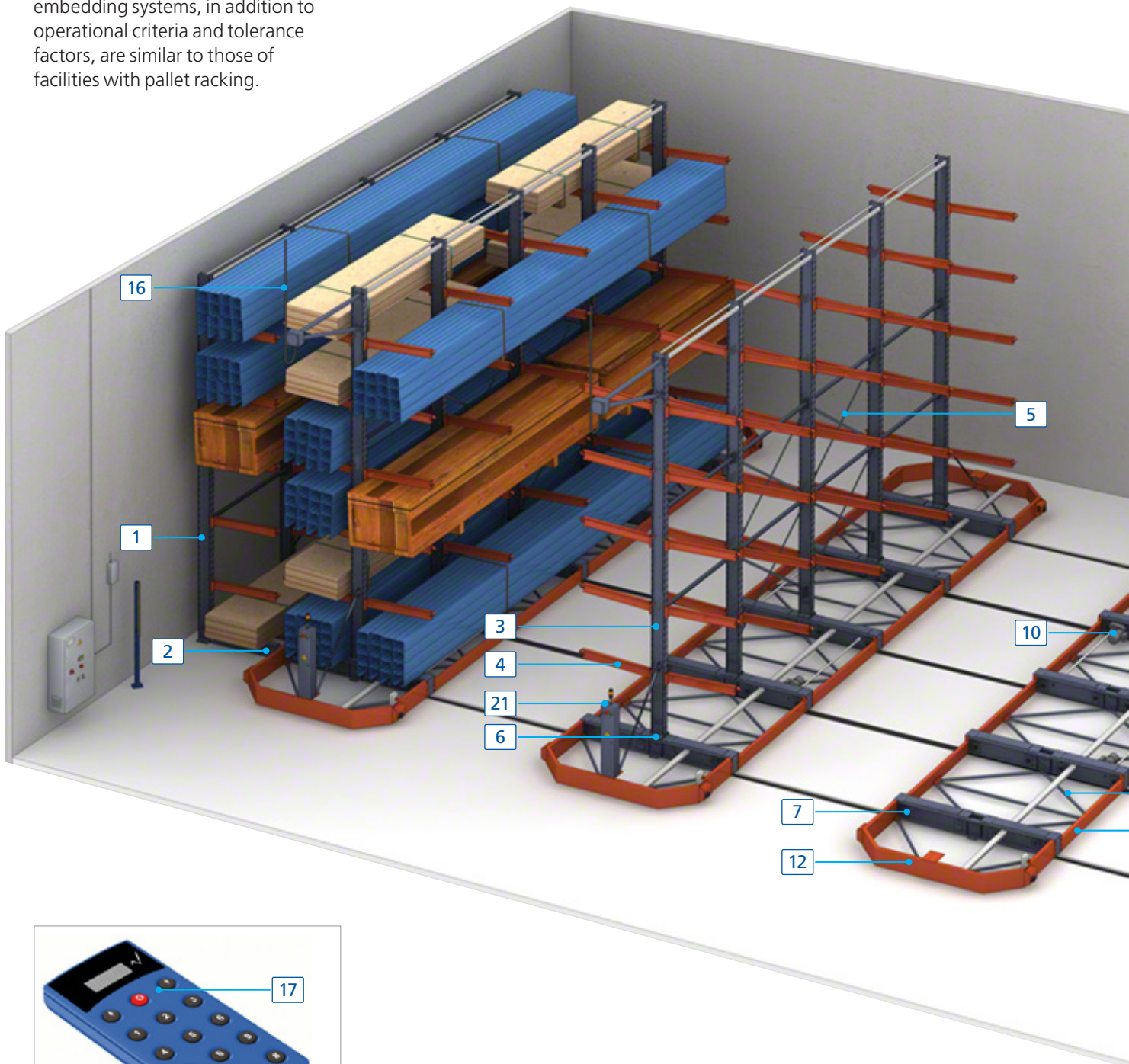

Racks

1. Single-deep column
2. Cantilever base
3. Double-deep column
4. Cantilever arm
5. Vertical cross bracing set
6. Column/base joint

Mobile bases

7. Carriage system (roller, drive, guide, end)
8. Base beam
9. Bracing set
10. Motor
11. Cable channel
12. Set of base brackets

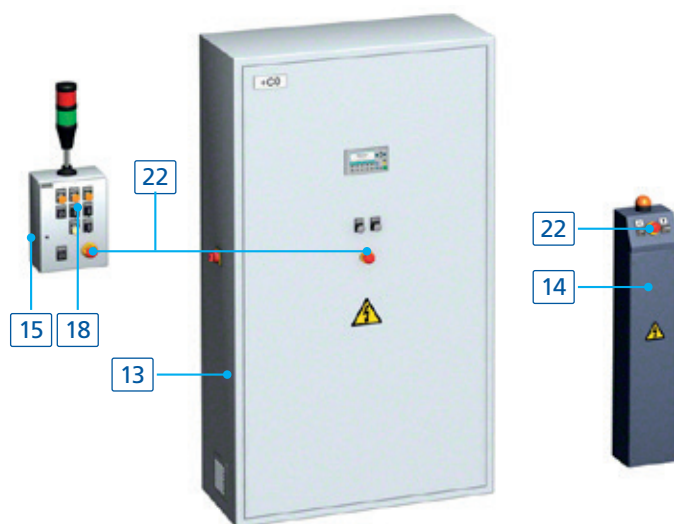
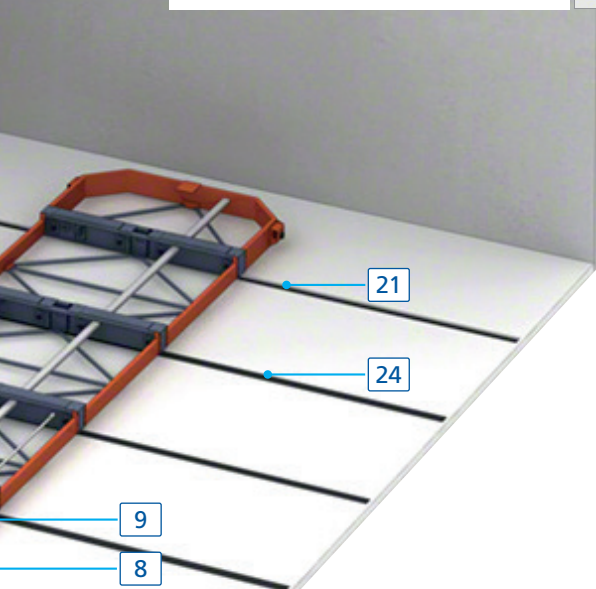
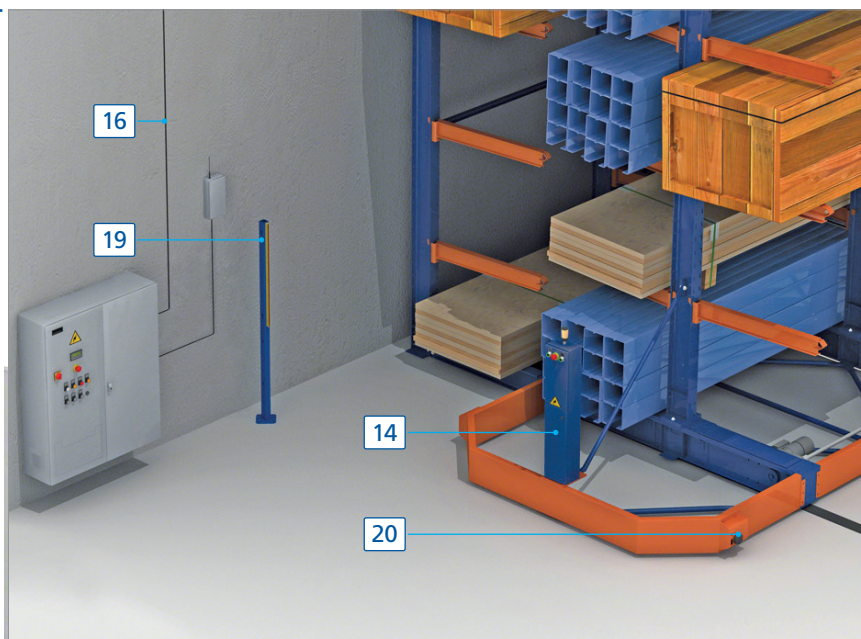

Control and safety elements

13. Main power panel
14. Onboard power panel
15. Control panel
16. Signal and power cables
17. Remote control
18. Control button pad
19. External safety barrier
20. Internal safety barrier and proximity photocell
21. Reset button
22. Emergency stop button

Embedded rails

23. Guide rail
24. Roller rail





External safety barrier

Controlling the facility

The basic features of the control system are found in the main power panel and the onboard control panels. These ensure the mobile racking units move safely and automatically.

The main control features found in the panel are:

- **The PLC controller**, the brains behind the facility and where the operational logic is programmed.
- **Power converters** to synchronise the operations of the different motors on the base, which provide a boost of acceleration and a smooth stop. These also lengthen the lifespan of several different components (motors, wheels, guides, etc.).
- **Error control screen**.
- **Aisle lighting control panel** (optional).



Remote control

Controls opening/closing and can reset the system without having to get down from the forklift.

Safety devices

The many built-in safety devices conform to current safety standards and guarantee the safe operation of the mobile equipment. Some of these devices include:

External safety barrier

When anyone crosses the external safety barrier of an open working aisle, either on foot or in a forklift, the power is automatically cut. This prevents the racking units from moving while someone is operating in the aisle.

The system can only be reset manually by pressing the reset button located at the top of the aisle or by remote control, once the safety protocol has been applied. This ensures that there are no operators working inside.

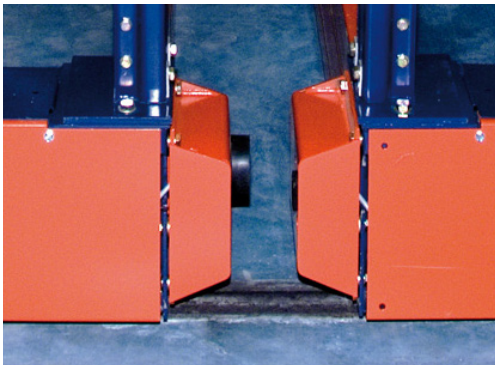
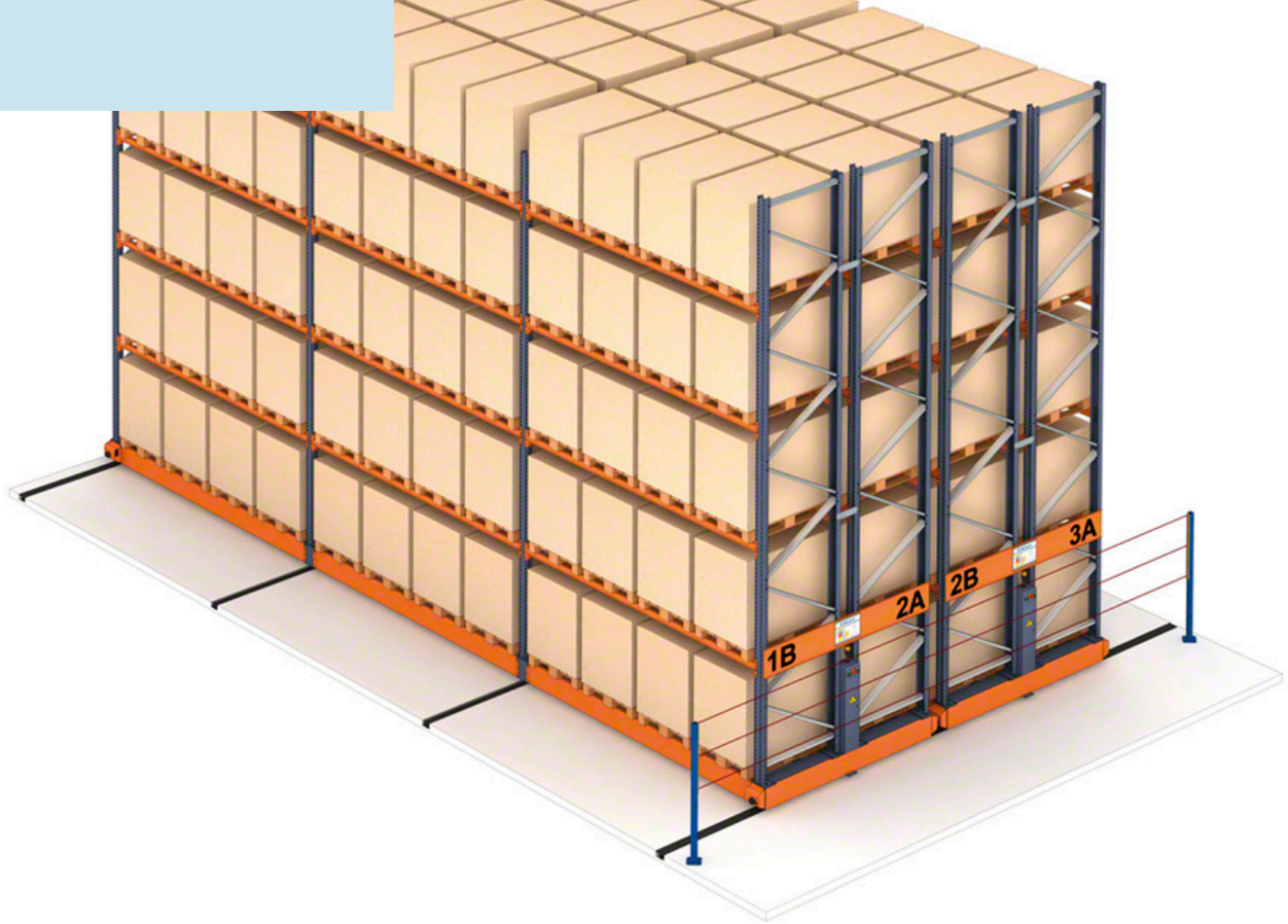

Internal safety barrier

On either side of the bases are longitudinal safety light barriers which cover the entire front of the mobile racking unit. In event of an emergency, the bases can be stopped by interrupting the beam of light with one's foot, for example. Moreover, this barrier detects the presence of foreign objects in the aisle that may impede safe operation.

Proximity photocell

This ensures a smooth, safe stop at the pre-programmed separation distance.



Reset buttons

These are located at the entrance of the aisle.



Emergency buttons

These are located in the onboard control panels and can stop the moving racks in an emergency.

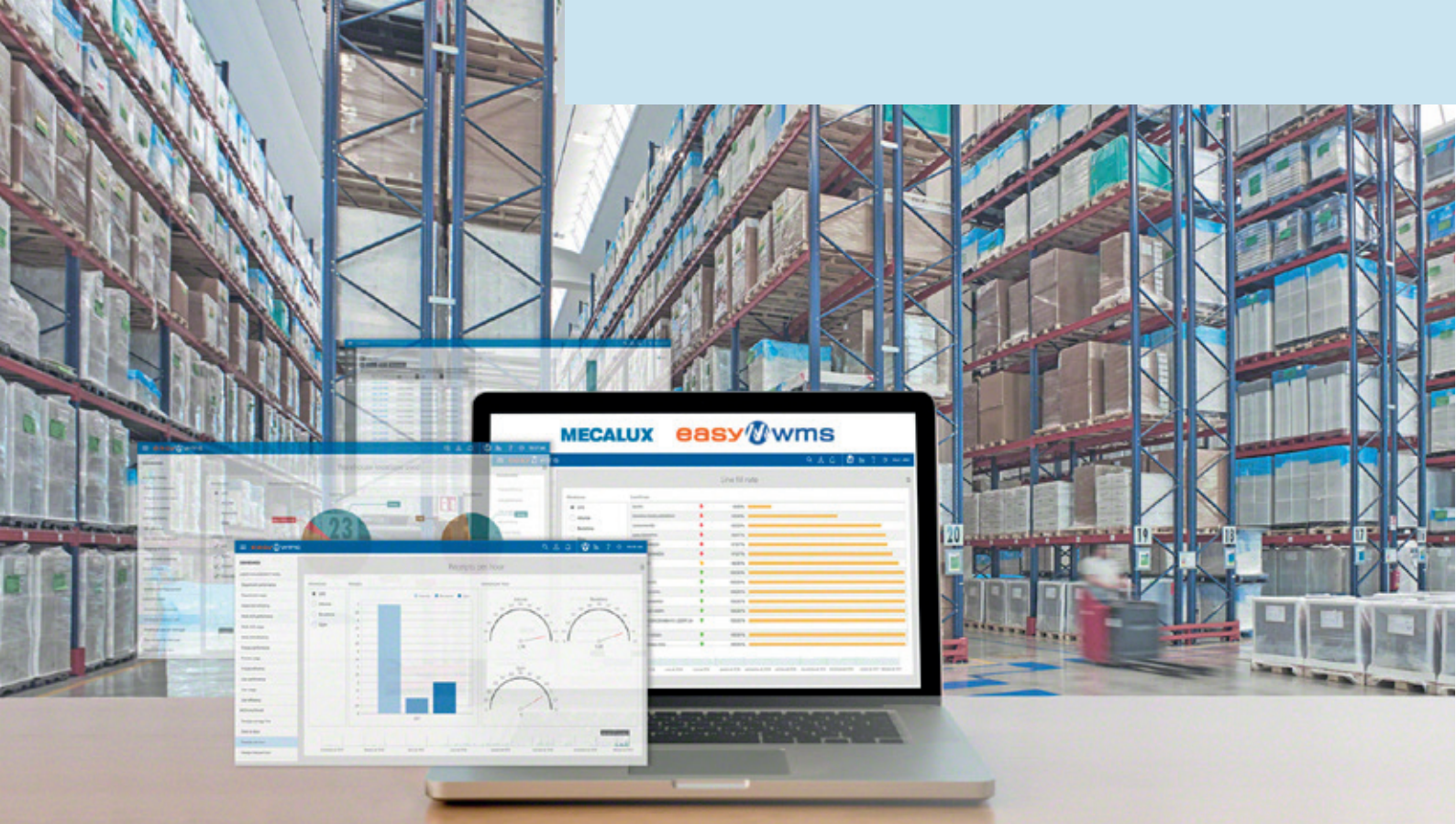

Easy WMS warehouse management system

The brain of the facility

Easy WMS is a powerful, versatile, scalable and flexible software program that can manage a manually operated warehouse (paper- or radiofrequency-device-run), a mixed facility or a large automated warehouse with the same efficiency.

Use it to streamline physical product flows and document management, from warehouse inputs to dispatches, for guaranteed, full end-to-end traceability.

Advantages

- > Real-time stock control
- > Lower logistics costs
- > Increased storage capacity
- > Reduced handling tasks
- > Error elimination
- > Accurate, high-speed picking
- > Adaptation to new e-commerce needs
- > Management of omnichannel operations
- > Fast ROI (in 12-18 months)



Mecalux works with leading suppliers that attest to the quality, reliability and technical level of the Easy WMS platform:



Microsoft Partner



Interconnected solutions for your supply chain



Multi Carrier Shipping Software
Automates product packaging, labelling and shipping. Coordinates direct communication between the warehouse and the various transport agencies.



Store Fulfillment
Synchronises inventory and workflows to ensure optimal stock management between the central warehouse and the network of brick-and-mortar shops.



Marketplaces & Ecommerce Platforms Integration
Synchronises the stock in the warehouse with the online catalogue in real time. Easy WMS automatically connects to the main digital sales platforms and marketplaces, e.g., Amazon, eBay and PrestaShop.



WMS for Manufacturing
Facilitates traceability in manufacturing processes. Guarantees the continuous supply of raw materials to the production lines.



Supply Chain Analytics Software
Analyses the thousands of pieces of data generated daily in a warehouse, allowing managers to make strategic decisions based on the real throughput of operations.

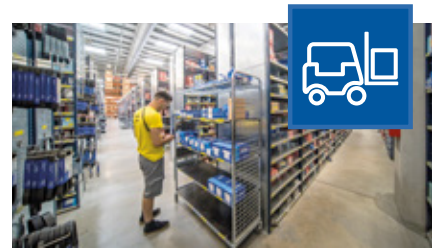

3PL Warehouse Management Software
Manages billing between a 3PL and its customers. A dedicated access platform provides information on stock condition and how to place orders or request customised shipments.



Yard Management System
Supervises the movement of vehicles in the yard at the warehouse or distribution centre. Optimises loading dock operations to improve vehicle flow and avoid bottlenecks with inbound and outbound goods.



Labor Management System (LMS)
Maximises operational productivity. It objectively measures operator throughput, detecting opportunities for improvement for the company.



Warehouse de Slotting Software
Optimises slotting management in the warehouse. It determines the optimal slotting for each SKU based on a set of predetermined rules and criteria (historic, current and future demand).

Easy WMS in the cloud

- » **Lower initial investment** since in-house servers are not needed.
- » Faster, simpler **implementation**.
- » Easier, more affordable **technical support and maintenance**. Total security with Microsoft Azure.
- » Software **version up-to-date** at all times.
- » **Maximum availability** to guarantee business continuity.
- » **Fees adapted** to the needs of each business.

Gartner

**MECALUX IN THE
2023 GARTNER®
MAGIC QUADRANT™
FOR WMS**

Gartner does not endorse any vendor, product or service depicted in its research publications, and does not advise technology users to select only those vendors with the highest ratings or other designation. Gartner research publications consist of the opinions of Gartner's research organisation and should not be construed as statements of fact. Gartner disclaims all warranties, expressed or implied, with respect to this research, including any warranties of merchantability or fitness for a particular purpose. GARTNER and MAGIC QUADRANT are a registered trademark and service mark of Gartner, Inc. and/or its affiliates in the U.S. and internationally and is used herein with permission. All rights reserved.



HEAD OFFICE - SPAIN - Silici, 1 - 08940 Cornellà de Llobregat - Barcelona
Tel. +34 932 616 913 – info@mecalux.com – mecalux.com

EUROPE

BELGIUM

Tel. +32 2 346 90 71
info@mecalux.be
mecalux.be

CZECHIA

Tel. +420 222 524 240
info@mecalux.cz
mecalux.cz

FRANCE

Tel. +33 01 60 11 92 92
info@mecalux.fr
mecalux.fr

GERMANY

Tel. +49 (0) 2133 5065 0
info@mecalux.de
mecalux.de

ITALY

Tel. +39 02 98836601
info@mecalux.it
mecalux.it

NETHERLANDS

Tel. +31 208 08 30 96
info@mecalux.nl
mecalux.nl

POLAND

Tel. +48 32-331 69 66
info@mecalux.pl
mecalux.pl

PORTUGAL

Tel. +351 21 415 18 90
info@mecalux.pt
mecalux.pt

SLOVAKIA

Tel. +421 220 545 117
info@mecalux.sk
mecalux.sk

TURKEY

Tel. +90 216 706 10 15
info@mecalux.com.tr
mecalux.com.tr

UNITED KINGDOM

Tel. +44 0121 3336 602
info@mecalux.co.uk
mecalux.co.uk

AMERICA

ARGENTINA

Tel. +54 (11) 4006-4444
info@mecalux.com.ar
mecalux.com.ar

BRAZIL

Tel. +55 19 3809-6800
info@mecalux.com.br
mecalux.com.br

CHILE

Tel. +56 (2) 2827 6000
info@mecalux.cl
mecalux.cl

COLOMBIA

Tel. +57 01 8000 423 553
info@mecalux.com.co
mecalux.com.co

MEXICO

Tel. +52 800 030 0185
info@mecalux.com.mx
mecalux.com.mx

URUGUAY

Tel. +598 2683-8879
info@mecalux.com.uy
mecalux.com.uy

USA

Tel. 1-877-632-2589
info@interlakemecalux.com
interlakemecalux.com

